

---

# i2home project



---

# Center of Excellence



# Center of Excellence

---

## Project Information:

Project Title: Accessible NetBeans / NetBeans Platform

Project Start Date: 1. 7. 2008

Project End Date: 30. 6. 2011



# i2home project

---

- n Controlling of home appliances of the new generation
- n Networked
- n New means of interaction



# State of the art controllers



This is what we want to avoid J





...since sometimes we feel like this

---



# Our primary target audience

---

The project is focusing on these user groups

- n** Elderly people - age  $\geq 65$
- n** Alzheimer disease patients
- n** People suffering with brain injuries
- n** People with visual impairments



# Technical and methodical aspects of the project

---

## Technical

- n Standardized technology
- n ISO/IEC 24752- $\{1-5\}$

## Methodological

- n User Centered Design (UCD)
- n Alan Cooper's approach
- n Usability and Accessibility





# The URC Framework—ISO/IEC 24752-{1-5}

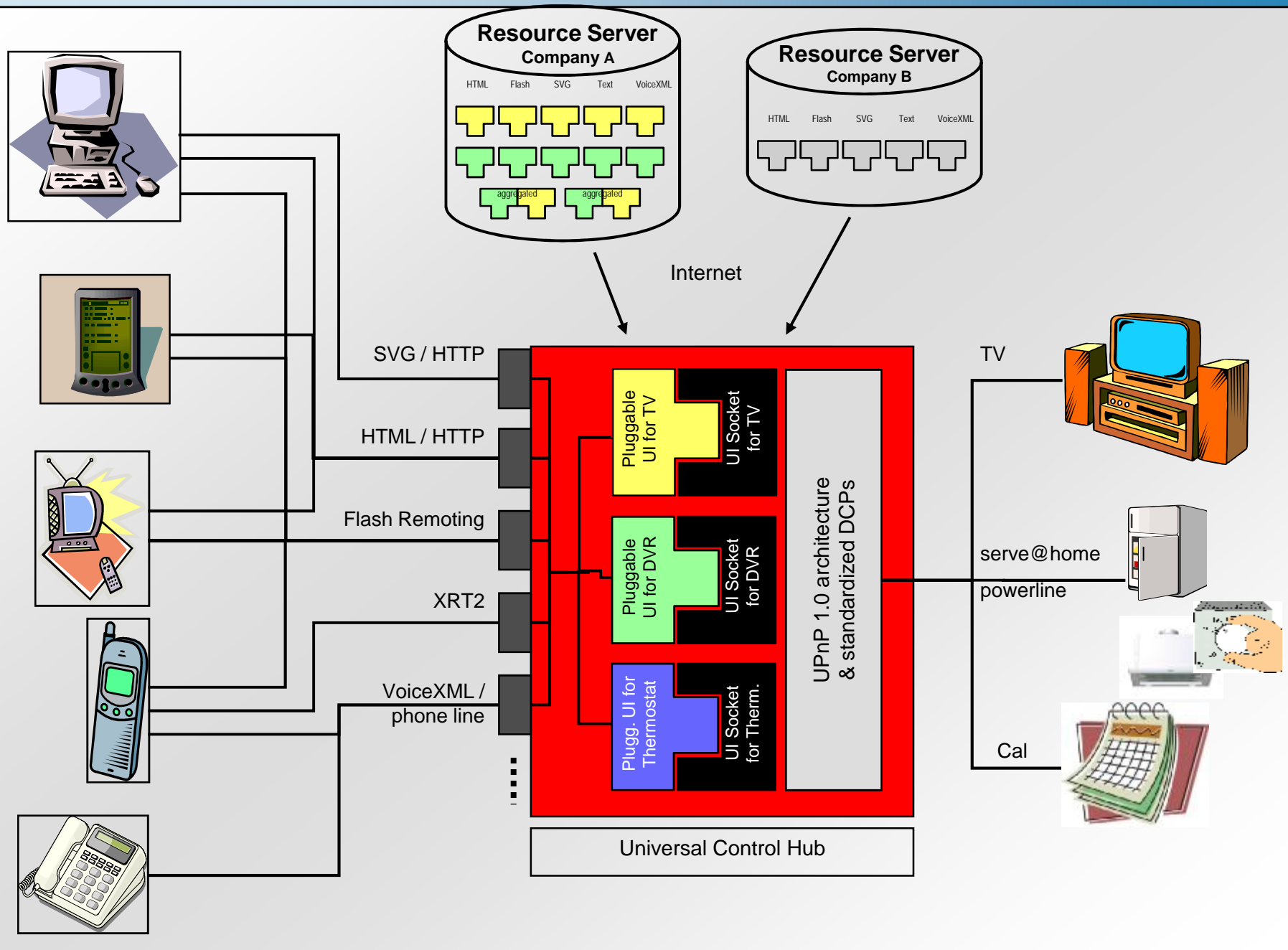

# User Centered Design - Personas

---



Blanka

Arnošt

Jiřina

Cyril



Manuela

María

Eva

Emma



# HVAC



**Air Conditioning** 

System is currently **On**  
Will stop at **17:45**

Chosen Temperature

**26°C**

Current **24°C**

**Weather**  **8°C**

**Air Conditioning** 

Current Temp **24°C**

Chosen Temp  

**Weather**  **8°C**  
**Fair, light wind**

# TV

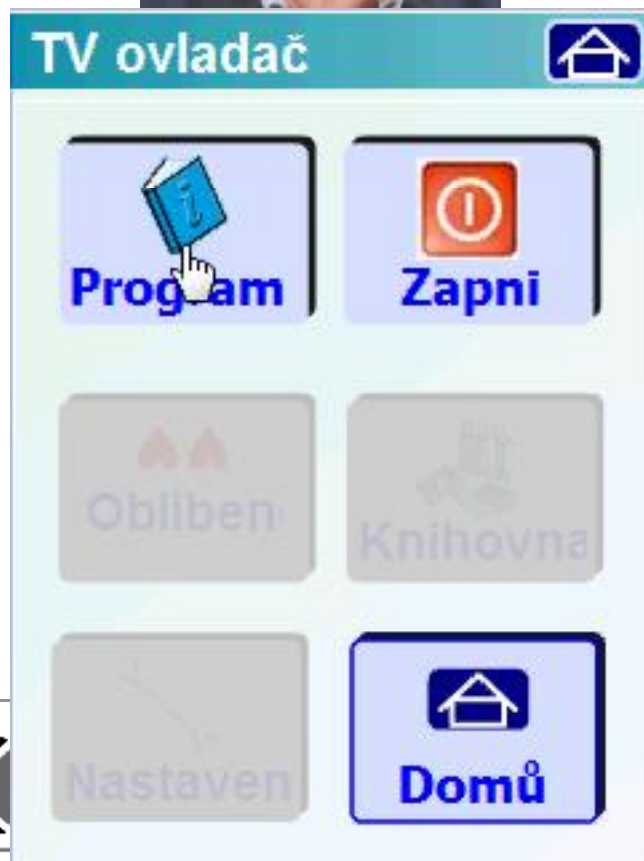



# TV



# Wrong ways



**Heating** 

Current Temp: **20.3°C**



Chosen Temp: **21.0°C**

Status:  
**System is ventilating (1:56)**

**+** Warmer  
**-** Colder

Current Mode: **At Home**

 **Fresh Air**

Weather:  **-15°C**   
**Cloudy, light wind**

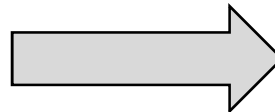

**Klimatizace** 

Aktuální teplota **24°C**

Cílová teplota **22°C**

**+**  
**-**

Počasí  **11°C**  
**Jasno, lehký vítr**



# TV with avatar - Manuela

---



# Results

---

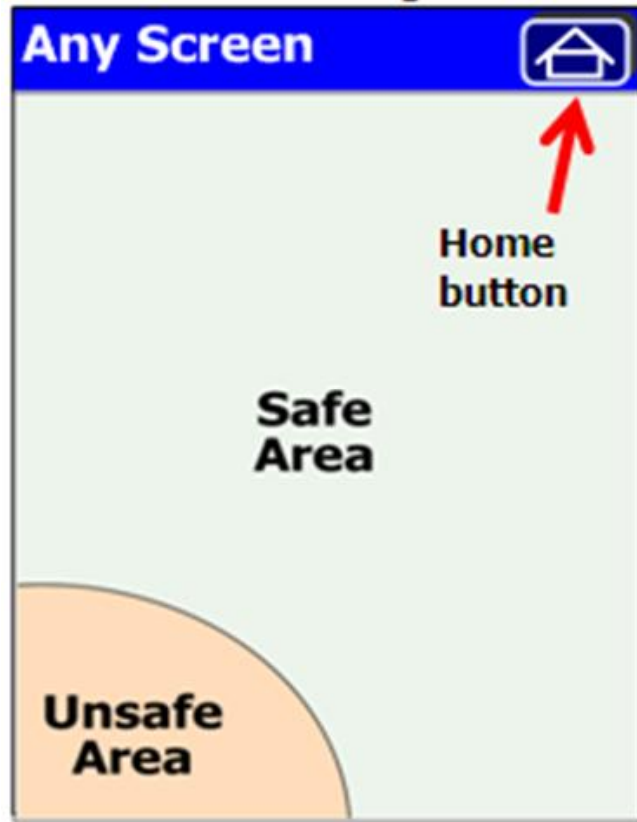

# Results

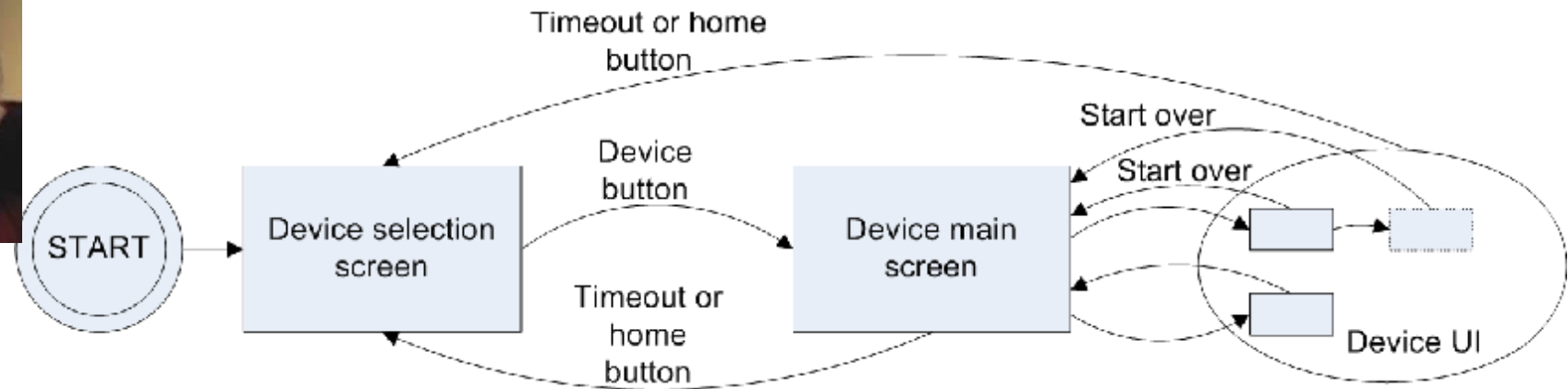
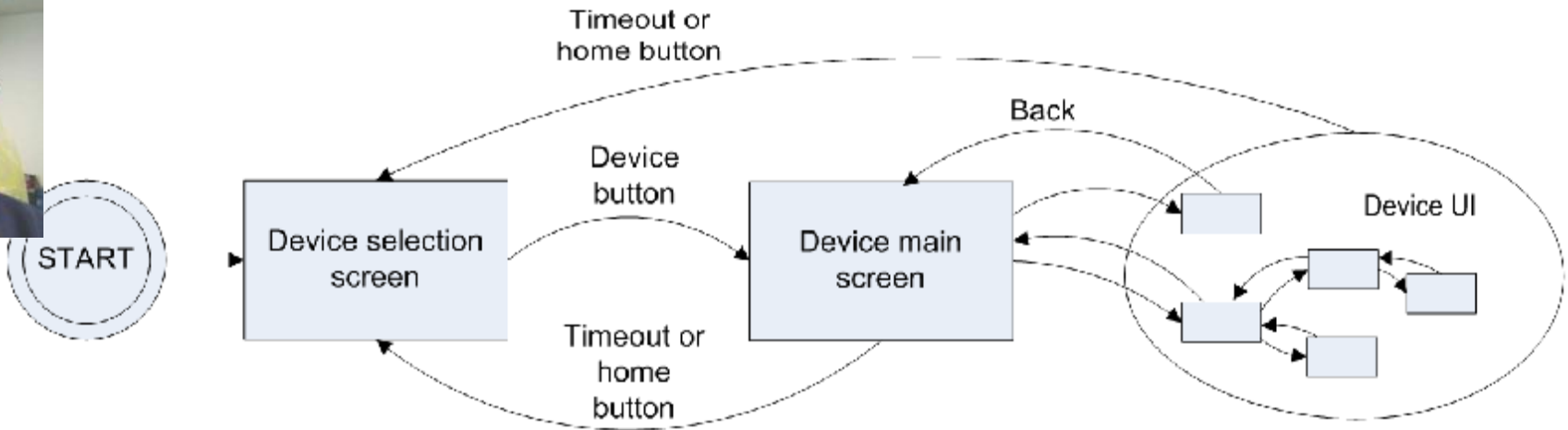

# Future work

---

- n TV as the major interacting point
- n Controlled by simplified IR RC
- n Health
- n Security
- n Social networking



# i2home consortium

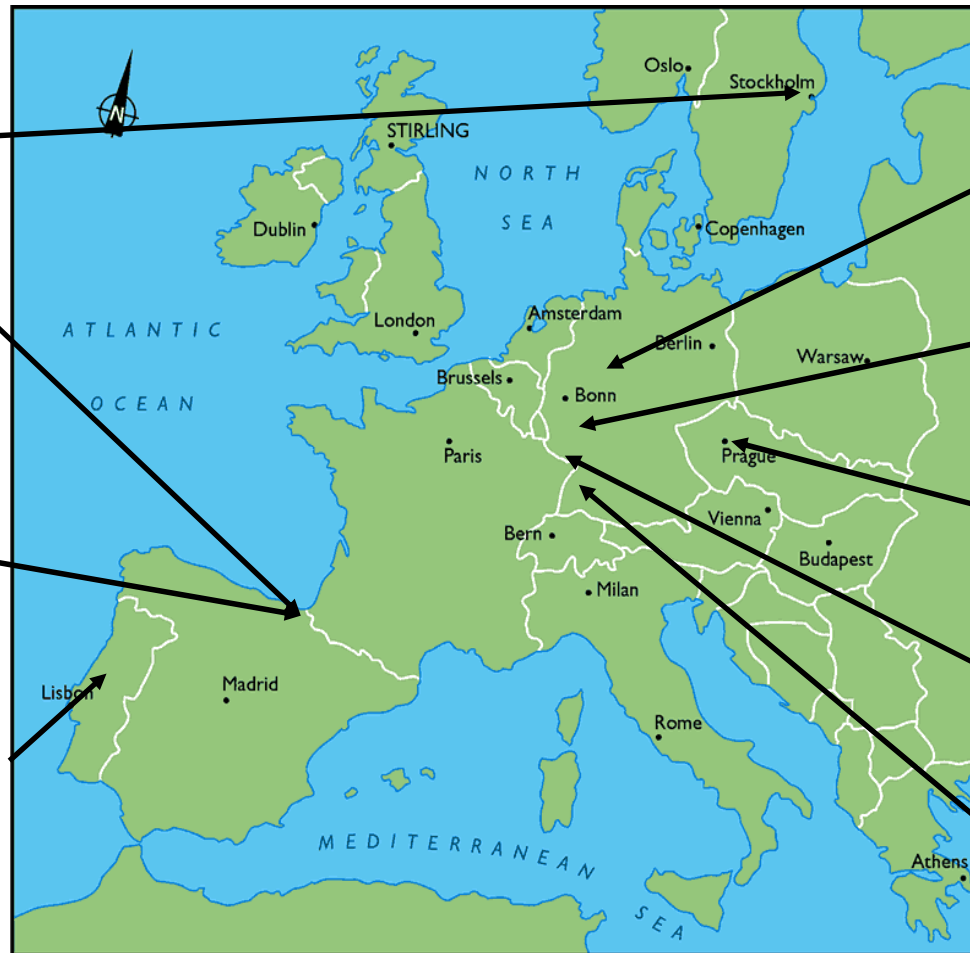

Zentrum für Graphische Datenverarbeitung e.V.



---

**THANK YOU  
FOR YOUR ATTENTION**

